

SNAP male L Bolt - M5 x 7 mm

patented technology

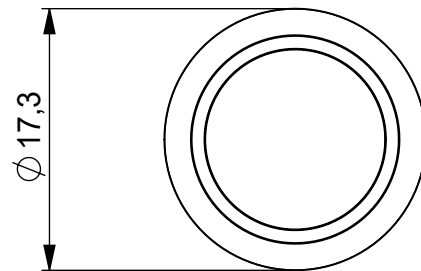

NOTE:
For assembly use hookwrench
with 2,5 mm cone

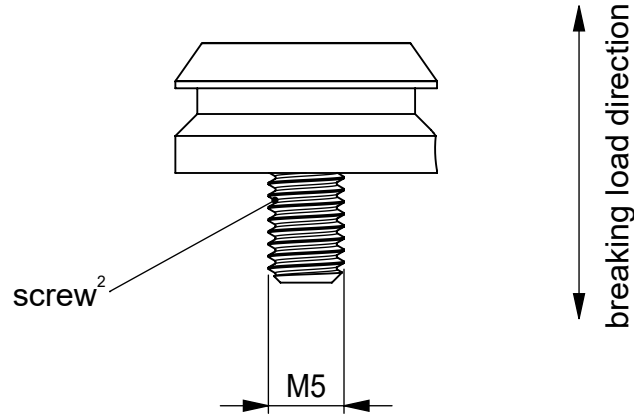
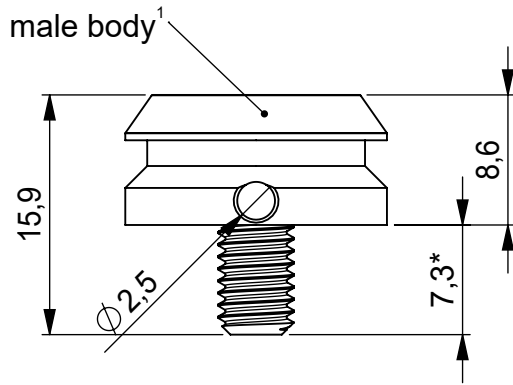
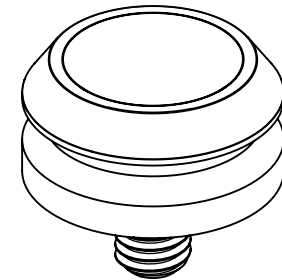

nominal values in millimeters [mm]

OPENING	depends on female part
MATERIAL	Aluminum¹, Steel (Zn coated)², NdFeB, Epoxy
COLOUR	Natural anodized/black anodized
WEIGHT	~ 7 g (weighed)
BREAKING LOAD	depends on female part

GENERAL NOTES*

Requires flat surface to be mounted on. All dimensions for reference only. *Dimensions might change due to process

ARTICLE NO.	05155
PRODUCT	SNAP male L bolt-M5x7
SCALE	2:1 DIN A4
REVISION / DATE	R00 05.07.23

* The manufacturer of the end products in which FIDLOCK fasteners are used, bears the responsibility for thoroughly testing that the FIDLOCK products are suitable for the intended applications.